

Data Sheet s4u[®] LC Connector

Numerous applications

FTTX and CATV Networks, LAN and Data Centers, Network Equipment Interface

Unique features

- space saving design with locked push-pull mechanism
- compact size for increased adapter density in patch-panels and short rigid length
- proven technology with excellent cost/performance ratio and high availability
- colored housing and clip for easy identification of product variants
- duplex clip for easy fixing of two simplex connectors



Specifications

Compliance	IEC 61754-20, TIA 604-10-A, RoHS
Alignment technology	1.25mm full ceramic ferrule (Zirconia ZrO ₂)
Operating temperature	-40°C to +85°C
Flammability	UL94 V-0
Durability	> 1000 mating cycles
Fiber, cable retention	IEC 61300-2-4; 100N on 2.0mm cables
Static side load	IEC 61300-2-42; 5N on 2.0mm cables
Transmission with applied tensile load	GR-326 CORE 4.4.3.5
Insertion loss, fiber core tunability	IEC 61755-3-1 / IEC 61755-3-2, Grade B
Color housing	blue: singlemode UPC green: singlemode APC 8° black or grey: multimode

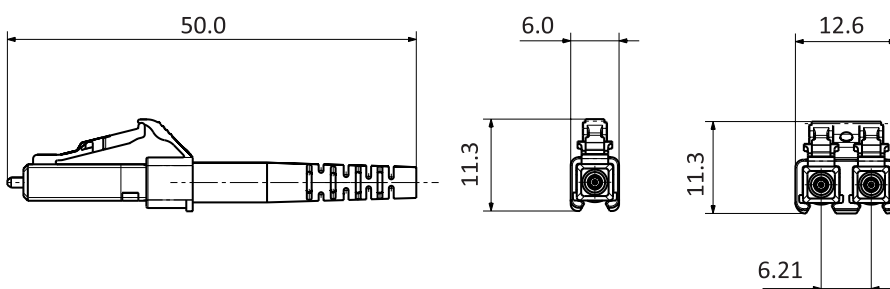

LC Connector

Order information

Order Code	Description	Color	Packing
CO-LC-APC-SX	Fiber Optic Connector LC/SM APC Simplex	green	200
CO-LC-UPC-SX	Fiber Optic Connector LC/SM UPC Simplex	blue	200
CO-LC-OM2-SX	Fiber Optic Connector LC/MM OM2 Simplex	grey	200
CO-LC-OM3-SX	Fiber Optic Connector LC/MM OM3 Simplex	aqua	200
CO-LC-OM4-SX	Fiber Optic Connector LC/MM OM4 Simplex	violet	200
CO-LC-MM-SX	Fiber Optic Connector LC/MM Simplex	black	200
CO-LC-APC-PT	Fiber Optic Connector LC/SM APC 0.9mm, green boot	black	200
CO-LC-UPC-PT	Fiber Optic Connector LC/SM UPC 0.9mm, blue boot	black	200
CO-LC-OM2-PT	Fiber Optic Connector LC/MM OM2 0.9mm, grey boot	black	200
CO-LC-OM3-PT	Fiber Optic Connector LC/MM OM3 0.9mm, aqua boot	black	200
CO-LC-OM4-PT	Fiber Optic Connector LC/MM OM4 0.9mm, violet boot	black	200
CO-LC-APC-PT-GRN	Fiber Optic Connector LC/SM APC 0.9mm, green boot	green	200
CO-LC-UPC-PT-BLU	Fiber Optic Connector LC/SM UPC 0.9mm, blue boot	blue	200

Data Sheet s4u® LC Duplex Clip

- material LSFH, flammability UL94 V-0
- compact design for simplex LC connector
- A-B channel mark

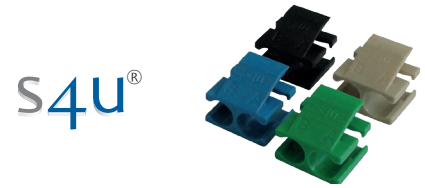

Order information

Order Code	Description	Color	Packing
CLIP-LC-GRN-DX	LC Duplex Clip green	green	500
CLIP-LC-BLU-DX	LC Duplex Clip blue	blue	500
CLIP-LC-GRY-DX	LC Duplex Clip grey	grey	500
CLIP-LC-BLK-DX	LC Duplex Clip black	black	500

Data Sheet s4u® LC Boot

- material LSFH, flammability UL94 V-0
- bend limiting design
- length 40mm



Order information

Order Code	Description	Color	Packing
BOOT-LC-GRN-20	LC Boot, 2.0mm	green	1000
BOOT-LC-BLU-20	LC Boot, 2.0mm	blue	1000
BOOT-LC-WHI-20	LC Boot, 2.0mm	white	1000
BOOT-LC-YEL-20	LC Boot, 2.0mm	yellow	1000
BOOT-LC-BRN-20	LC Boot, 2.0mm	brown	1000
BOOT-LC-GRY-20	LC Boot, 2.0mm	grey	1000
BOOT-LC-RED-20	LC Boot, 2.0mm	red	1000
BOOT-LC-VIO-20	LC Boot, 2.0mm	violet	1000
BOOT-LC-PNK-20	LC Boot, 2.0mm	pink	1000
BOOT-LC-AQU-20	LC Boot, 2.0mm	aqua	1000
BOOT-LC-BLK-20	LC Boot, 2.0mm	black	1000
BOOT-LC-ORA-20	LC Boot, 2.0mm	orange	1000
BOOT-LC-GRN-30	LC Boot, 3.0mm	green	1000
BOOT-LC-BLU-30	LC Boot, 3.0mm	blue	1000
BOOT-LC-BLK-30	LC Boot, 3.0mm	black	1000
BOOT-LC-RED-30	LC Boot, 3.0mm	red	1000

Data Sheet s4u[®] LC Crimp Sleeve

- aluminium RoHS compliant
- crimp die size 3.3mm
- cable jacket fixation integrated



Order information

Order Code	Description	Color	Packing
CRPSL-LC-19	LC Crimp Sleeve for cables with nominal diameter 1.9 – 2.0mm	Aluminium	2000
CRPSL-LC-27	LC Crimp Sleeve for cables with nominal diameter 2.7 – 2.9mm	Aluminium	2000

Data Sheet s4u[®] LC Duplex Adapter with 2-hole flange

- 2-hole flange for screw mounting
- integrated metal latches for snap mounting
- SC cut-out compatible
- ceramic precision alignment sleeve

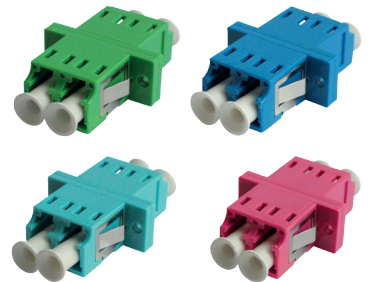

S4U[®]

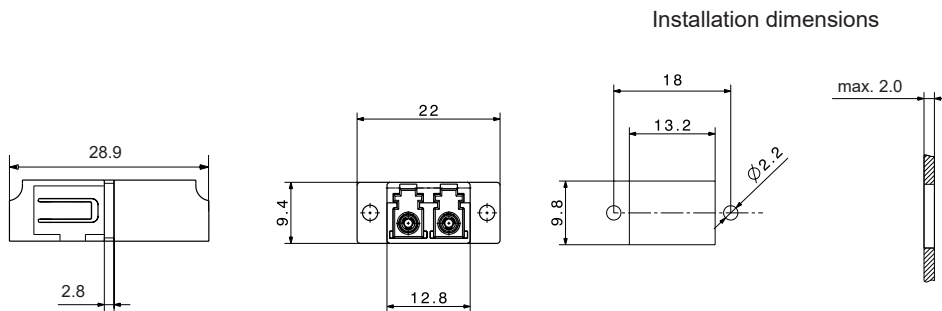

Order information

Order Code	Description	Color	Packing
AD-LC-DX-2HM-GRN	Fiber Optic Adapter LC/SM APC Duplex, SC-shape, 2-hole flange	green	100
AD-LC-DX-2HM-BLU	Fiber Optic Adapter LC/SM UPC Duplex, SC-shape, 2-hole flange	blue	100
AD-LC-DX-2HM-AQU	Fiber Optic Adapter LC/MM OM3 Duplex, SC-shape, 2-hole flange	aqua	100
AD-LC-DX-2HM-VIO	Fiber Optic Adapter LC/MM OM4 Duplex, SC-shape, 2-hole flange	violet	100

LC Duplex Adapter with short flange

- short flange for high density applications
- integrated metal latches for snap mounting
- SC cut-out compatible
- ceramic precision alignment sleeve



S4U[®]

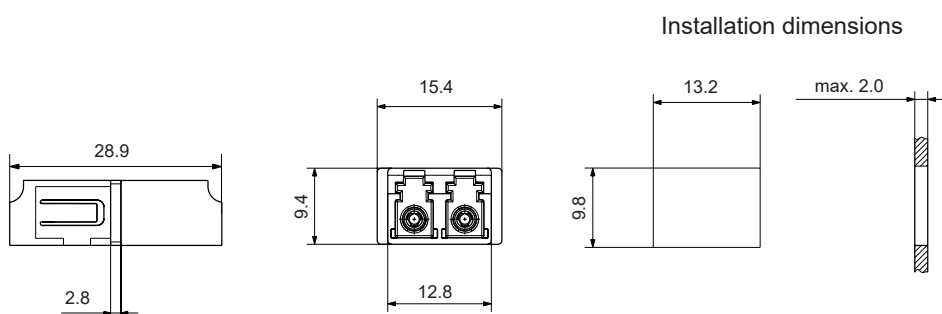

Order information

Order Code	Description	Color	Packing
AD-LC-DX-SFM-GRN	Fiber Optic Adapter LC/SM APC Duplex, SC-shape, short flange	green	100
AD-LC-DX-SFM-BLU	Fiber Optic Adapter LC/SM UPC Duplex, SC-shape, short flange	blue	100
AD-LC-DX-SFM-AQU	Fiber Optic Adapter LC/MM OM3 Duplex, SC-shape, short flange	aqua	100
AD-LC-DX-SFM-VIO	Fiber Optic Adapter LC/MM OM4 Duplex, SC-shape, short flange	violet	100

Data Sheet s4u[®] LC Quad Adapter with 2-hole flange

- 2-hole flange for screw mounting
- integrated plastic latches for snap mounting
- SC Duplex cut-out compatible
- ceramic precision alignment sleeve

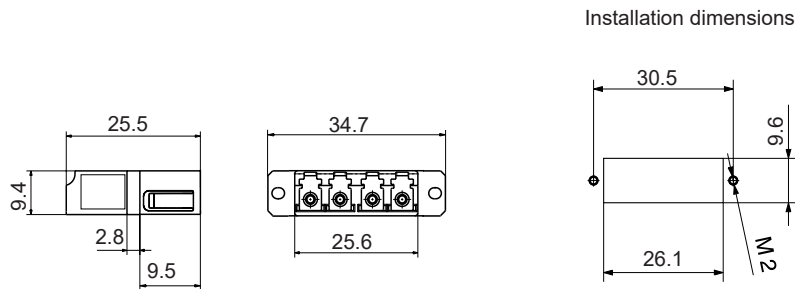
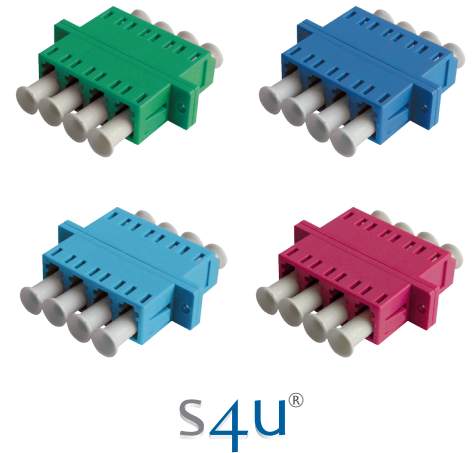

Order information

Order Code	Description	Color	Packing
AD-LC-QU-2HP-GRN	Fiber Optic Adapter LC/SM APC Quad, 2-hole flange	green	100
AD-LC-QU-2HP-BLU	Fiber Optic Adapter LC/SM UPC Quad, 2-hole flange	blue	100
AD-LC-QU-2HP-AQU	Fiber Optic Adapter LC/SM UPC Quad, 2-hole flange	aqua	100
AD-LC-QU-2HP-VIO	Fiber Optic Adapter LC/MM OM4 Quad, 2-hole flange	violet	100

LC Quad Adapter with short flange

- short flange for high density applications
- integrated plastic latches for snap mounting
- SC Duplex cut-out compatible
- ceramic precision alignment sleeve

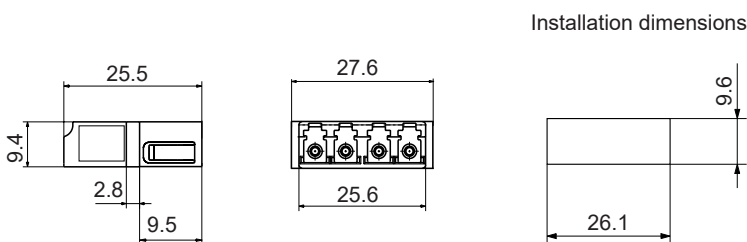
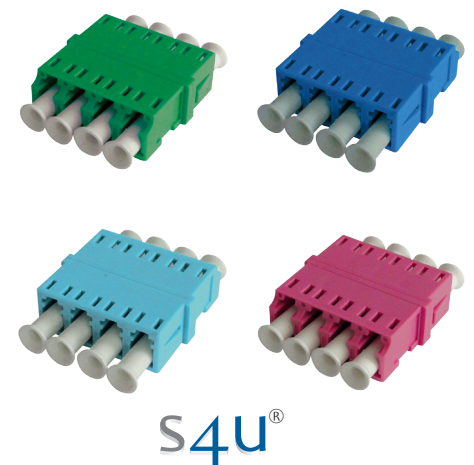

Order information

Order Code	Description	Color	Packing
AD-LC-QU-SFP-GRN	Fiber Optic Adapter LC/SM APC Quad, short flange	green	100
AD-LC-QU-SFP-BLU	Fiber Optic Adapter LC/SM UPC Quad, short flange	blue	100
AD-LC-QU-SFP-AQU	Fiber Optic Adapter LC/MM OM3 Quad, short flange	aqua	100
AD-LC-QU-SFP-VIO	Fiber Optic Adapter LC/MM OM4 Quad, short flange	violet	100

Data Sheet s4u[®] LC Pigtail

Numerous applications

BTW – Behind-The-Wall application in high-density passive optical networks

Unique features

- meets Telcordia GR-0326-CORE requirements for high-density applications
- very short rigid length for space saving installations
- colored connector boots for easy identification of product variants
- Pigtail-sets with 12 different 0.9mm tube/fiber colors, optionally dashed for 24-fiber sets



Specifications

LC Connector compliance	IEC 61754-20, TIA 604-10-A, RoHS
Alignment technology	Full ceramic ferrule (Zirconia ZrO ₂)
Operating temperature	-40°C to +85°C
Flammability	UL94 V-0
Durability	> 1000 mating cycles
Transmission with applied tensile load	GR-0326-CORE 4.4.3.5
Optical performance, insertion loss	Singlemode: ≤ 0.30dB Multimode: ≤ 0.25dB Multimode low-loss: ≤ 0.15dB
Optical performance, return loss	Singlemode UPC: ≥ 50dB Singlemode APC: ≥ 65dB Multimode: ≥ 35dB
Cable types	0.9mm easy-strip (12 colors + 12 colors dashed) 0.9mm tight-tube
Connector end face geometry	IEC 61755-3

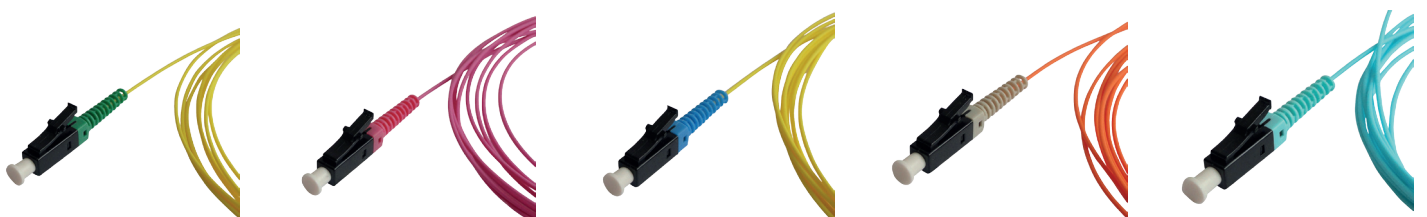
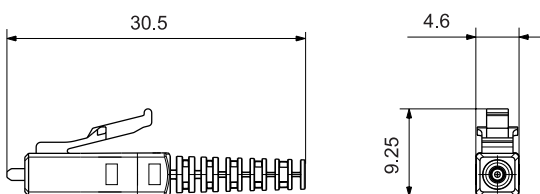

Data Sheet s4u[®] LC Patchcord

Numerous applications

FTTX and CATV Networks, LAN and Data Centers, Network Equipment Interface
according to IEC 61753-1 Category U - controlled environment

Unique features

- low insertion loss and excellent repeatability
- compact and robust latched push-pull connector
- proven technology with high availability
- various customizing options



Specifications

Optical Interface	
Insertion loss, IEC 61300-3-4-B	Singlemode: $\leq 0.25\text{dB}$ Multimode: $\leq 0.25\text{dB}$
Return loss, IEC 61300-3-6	Singlemode UPC: $\geq 50\text{dB}$ / APC: $\geq 80\text{dB}$ Multimode: $\geq 35\text{dB}$
End face geometry	IEC 61755-3-1/-2
Fiber core tuning option	IEC 61755-3-1/-2 Grade B (0.25dB on 97%, 0.12dB on 50%)
Environmental Resistance	
Cable retention	IEC 61300-2-4, 100N on $>2.0\text{mm}$ cable / 70N $\leq 2.0\text{mm}$
Static side load	IEC 61300-2-42, 5N on $\geq 2.0\text{mm}$ cable
Mating Durability	IEC 61300-2-2, > 1000 mating cycles
Torsion	IEC 61300-2-5, 15N/25cycles
Operating temperature	IEC 61300-2-22, -25° to 70°C
Cable types	
Material	LSZH – Low Smoke Zero Halogens (RoHS compliant)
Diameter	1.7mm, 2.0mm, 2.8mm
Colors	SM yellow, MM OM2 orange, MM OM3 aqua MM OM4 violet, MM OM5 lime green

LC connector with colored Duplex Clip

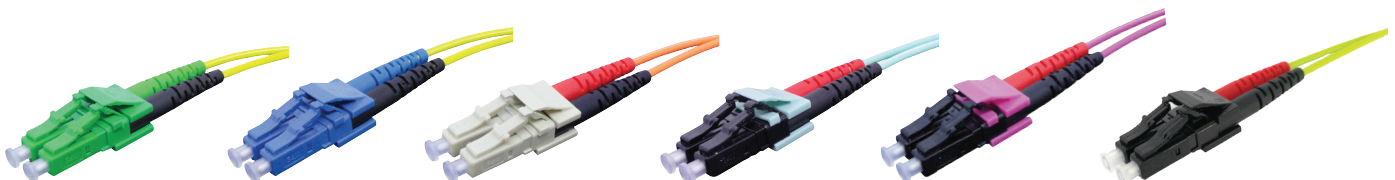

LC Patchcord Order Code Structure

1. Cable Type		2. Connector le/ri			3. Fiber Type		4. Cable Diameter		5. Length	
PC	Simplex Cable	LCA	LC	APC SM	SM	SM G652D	S17	1.7mm	1	1m
PCD	Duplex Fig.8 (Zip Cord)	LCU	LC	UPC SM	A1	SM G657A1	S20	2.0mm	1.5	1.5m
PCR	Duplex Fig.0 (Flat Twin)	LCM	LCM	LC MM	A2	SM G657A2	S28	2.8mm		etc.
					O2	MM OM2				
					O3	MM OM3				
					O4	MM OM4				
					O5	MM OM5				

Order Code Examples

Order Code	Description	Packing
PC-LCA/LCA-SM-S17-1.0	Patchcord Simplex, LC/APC to LC/APC, SM G652D 1.7mm, 1m, yellow	1
PCD-LCA/LCU-A2-S20-3.5	Patchcord Duplex Fig.8, LC/APC to LC/UPC, SM G657A2 2.0mm, 3.5m, yellow	1
PCR-LCM/LCM-O4-S28-5.0	Patchcord Duplex Fig.0, LC/MM to LC/MM, MM 50µm OM4 2.8mm, 5.0m, violet	1

Data Sheet s4u[®] LC UNIBOOT Patchcord

Numerous applications

FTTX and CATV Networks, LAN and Data Centers, Network Equipment Interface
according to IEC 61753-1 Category C - controlled environment

Unique features

- low insertion loss and excellent repeatability
- space saving and robust cable with 2 fibers in one jacket
- easy polarity flipping with no tools
- various customizing options



Specifications

Optical Interface	
Insertion loss, IEC 61300-3-4-B	Singlemode: $\leq 0.25\text{dB}$ Multimode: $\leq 0.25\text{dB}$
Return loss, IEC 61300-3-6	Singlemode UPC: $\geq 50\text{dB}$ / APC: $\geq 80\text{dB}$ Multimode: $\geq 35\text{dB}$
End face geometry	IEC 61755-3-1/-2
Environmental Resistance	
Cable retention	IEC 61300-2-4, 50N
Static side load	IEC 61300-2-42, 1N
Mating Durability	IEC 61300-2-2, > 500 mating cycles
Torsion	IEC 61300-2-5, 5N/25cycles
Operating temperature	IEC 61300-2-22, -10° to 60°C
Cable types	
Material	LSZH – Low Smoke Zero Halogens (RoHS compliant)
Diameter	2.1mm
Colors	SM yellow / MM orange (OM2), aqua (OM3), violet (OM4)

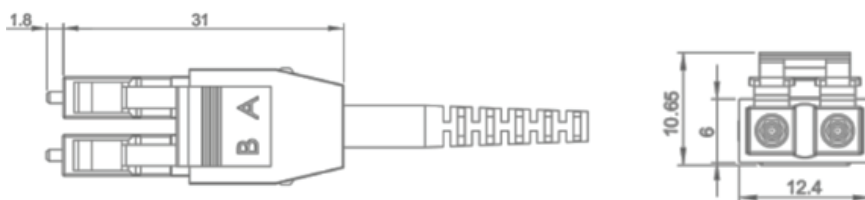

LC UNIBOOT Polarity Flipping

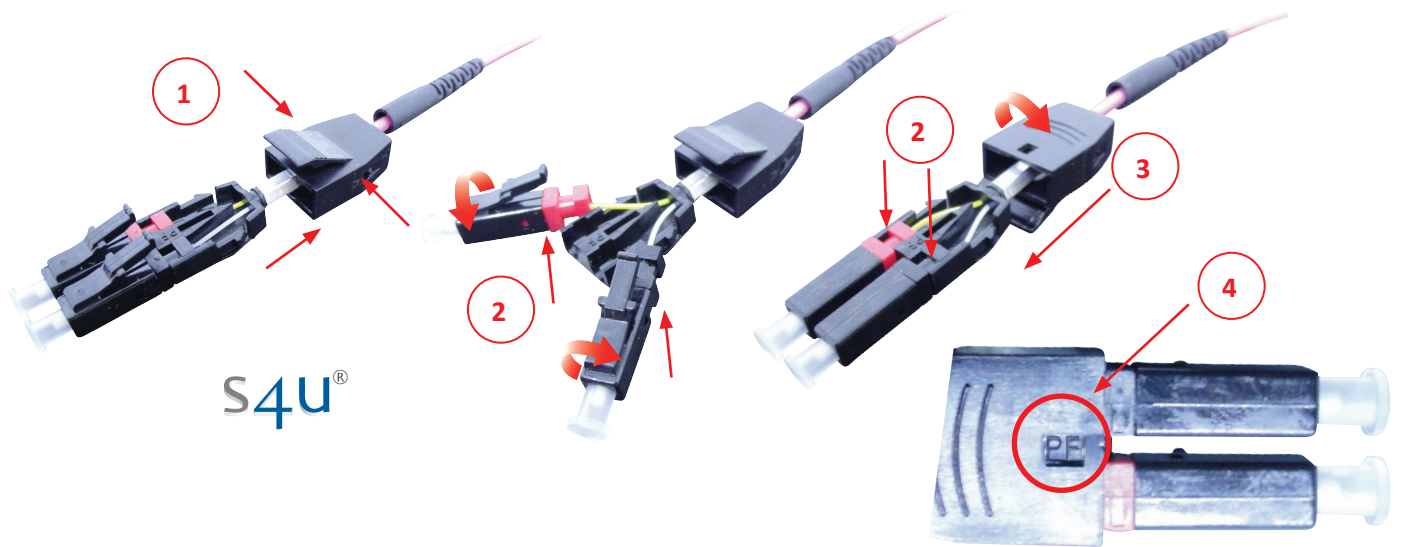

1. Press latches on both sides and pull-back housing
2. Remove first connector and turn it upside down, repeat it with the second connector and put both back in their positions
3. Turn the housing upside down and slide it over the connectors until it snaps in
4. "PF" will become visible in the window – polarity is now flipped

LC Uniboot Patchcord Order Code Structure

1. Cable Type	2. Connector le/ri	3. Fiber Type	4. Cable Diameter	5. Length
PCR Round Duplex Cable	LCUA LC APC SM	SM SM G652D	T21 2.1mm	1 1m
	LCUU LC UPC SM	A1 SM G657A1		1.5 1.5m
	LCUM LC LC MM	A2 SM G657A2		etc.
		O2 MM OM2		
		O3 MM OM3		
		O4 MM OM4		

Order Code Examples

Order Code	Description	Packing
PCR-LCUA/LCUA-SM-T21-2.0	Patchcord Duplex, LC Uniboot/APC to LC Uniboot/APC Uniboot, SM G652D 2.1mm, 1m	1
PCR-LCUM/LCUM-O4-T21-3.5	Patchcord Duplex, LC Uniboot/MM to LC Uniboot/MM, MM 50µm OM4 2.1mm, 3.5m	1

Data Sheet s4u[®] LC/SM Plugtype Attenuator

Numerous applications

Passive Optical Networks, WDM systems, optical receivers

Unique features

- latched push-pull type, small form factor (1.25mm ferrule)
- high stability and reliability
- wavelength independent
- LC interface according to IEC 61754-20



Specifications

Operation wavelength	1260 to 1625nm
Return loss	≥ 55dB (UPC)
	≥ 65dB (APC)
Attenuation tolerance	±0.5 dB for 1 to 5dB attenuation
	±10% for 6 to 30dB attenuation
Polarization dependent loss	≤ 0.2dB
Maximum optical input power	200mW
Operating temperature range	-40 to +80°C
Durability	1000 mating cycles

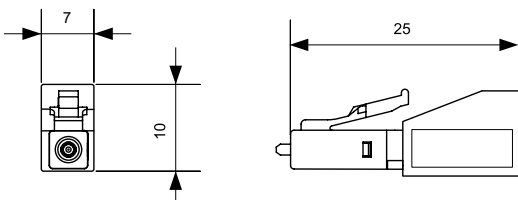

Order information

Order code	Description	Color	Packing
ATT-LCA-XX	LC APC attenuator xx dB (attenuation 01-20dB in 1dB steps)	green	1
ATT-LCU-XX	LC UPC attenuator xx dB (attenuation 01-20dB in 1dB steps)	blue	1